

Lighting of London

Product Datasheet

Profiles

+ (44) 0207 139 5129

enquiries@lightingoflondon.co

Manufactured to the highest standards, all our aluminium profiles are supplied with end caps and fixing clips, perfect for heat dissipation, with an opal diffuser to eliminate LED spotting. Profiles are supplied in 2-metre lengths.

-If installing an LED strip into a profile and the placement of the profile will be directly visible, please refer to the guide below:

Line

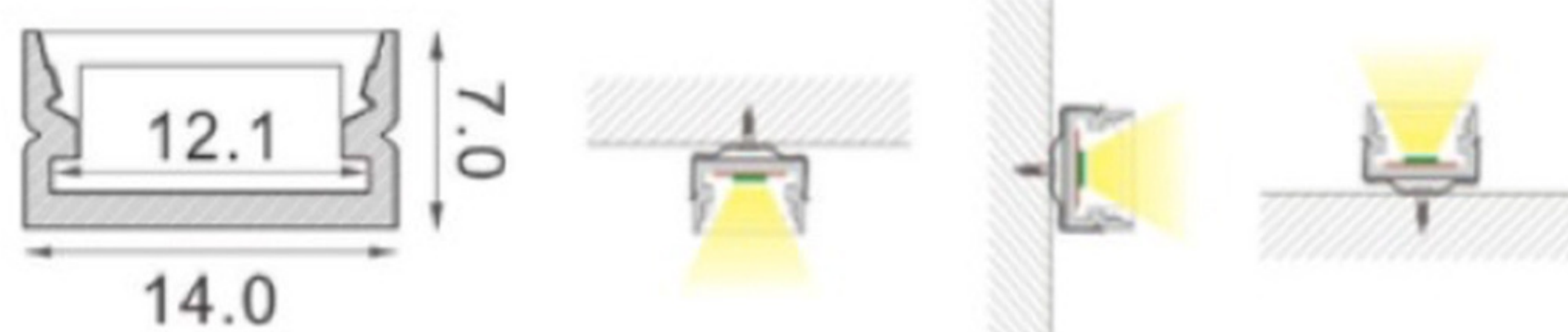

Linear.240- No Spotting
Linear.350- No Spotting
Linear.RGBW- Spotting Visible

Cove

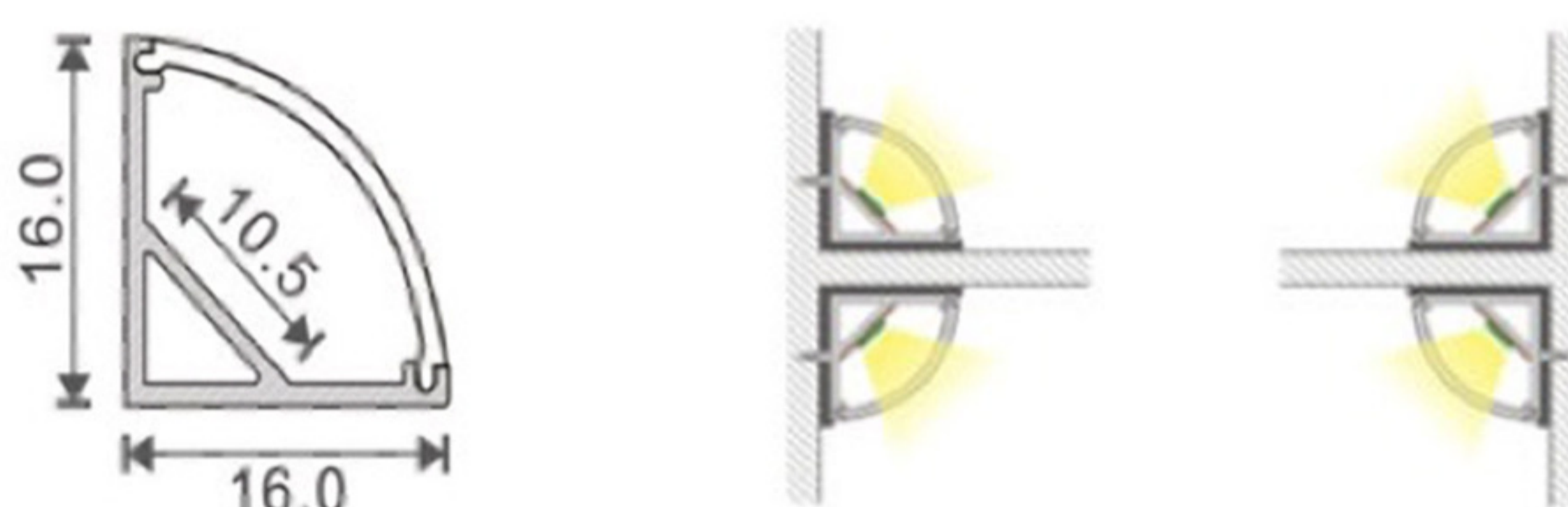
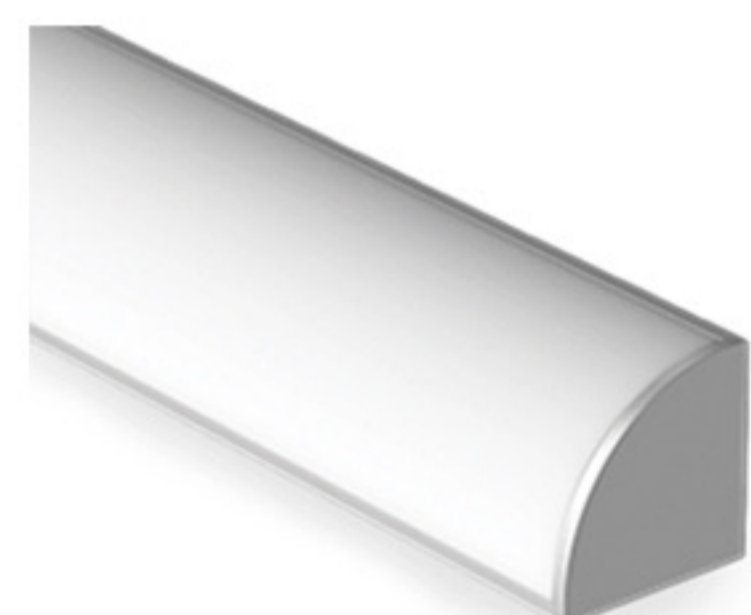

Linear.240- No Spotting
Linear.350- No Spotting
Linear.RGBW- Spotting Visible

Wash

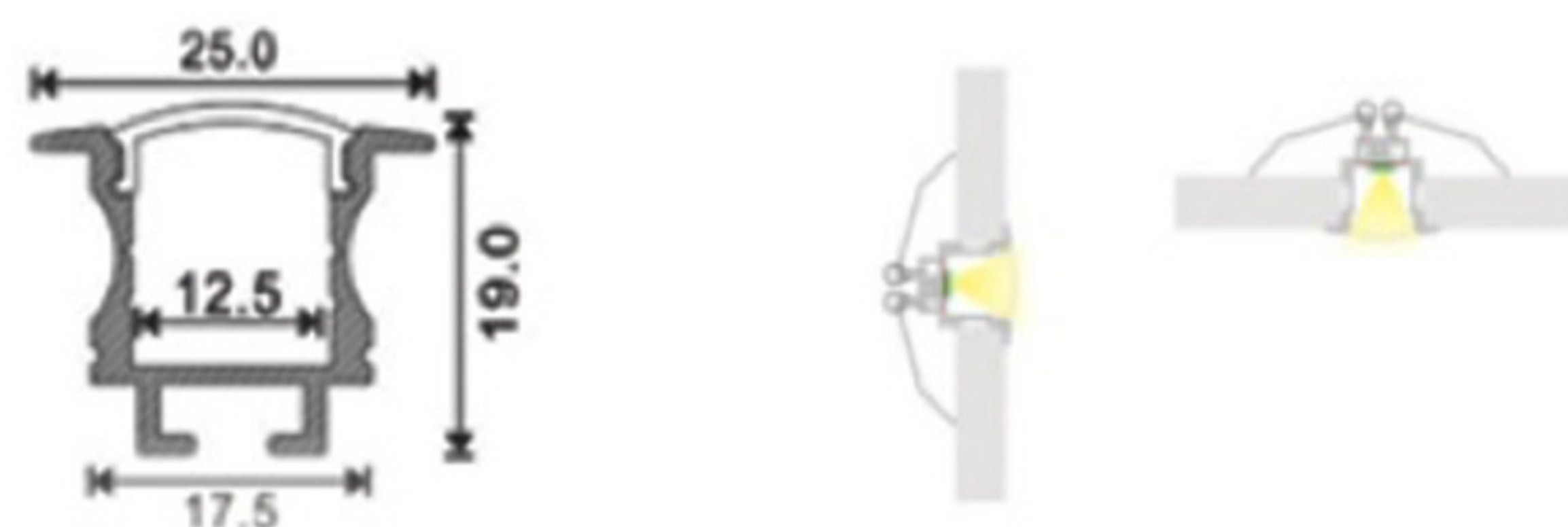

Linear.240- No Spotting
Linear.350- No Spotting
Linear.RGBW- Spotting Visible

Plaster

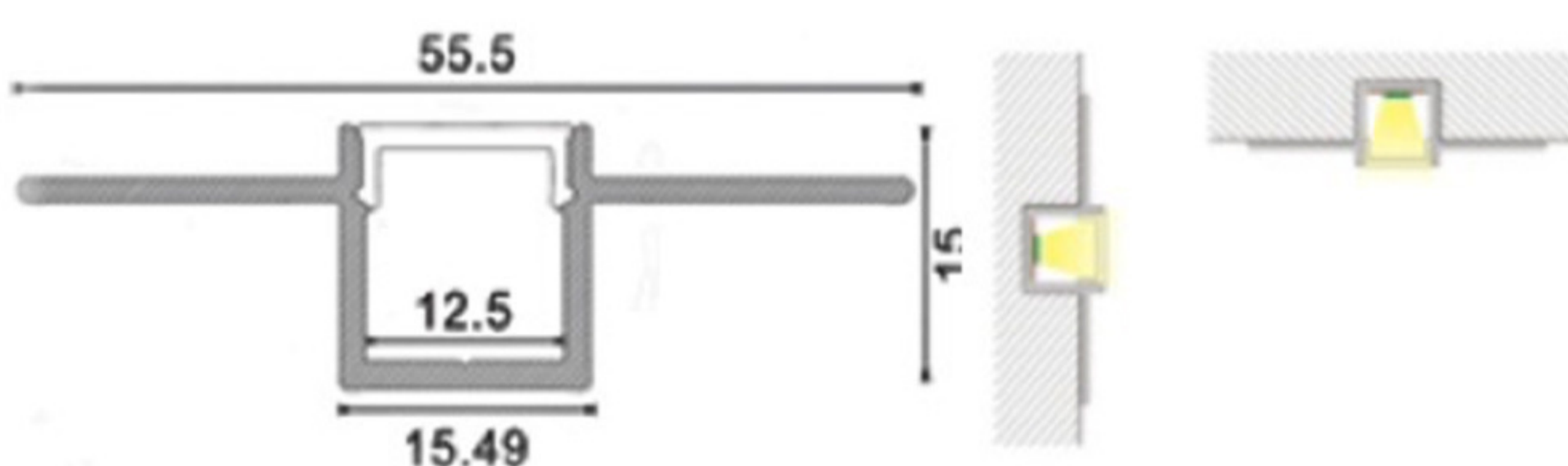
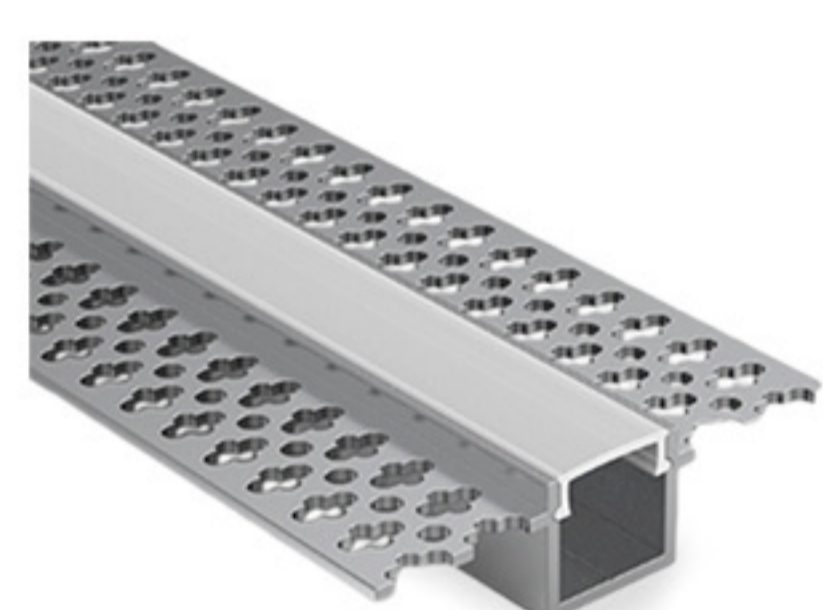

Linear.240- No Spotting
Linear.350- No Spotting
Linear.RGBW- Spotting Visible

Lean

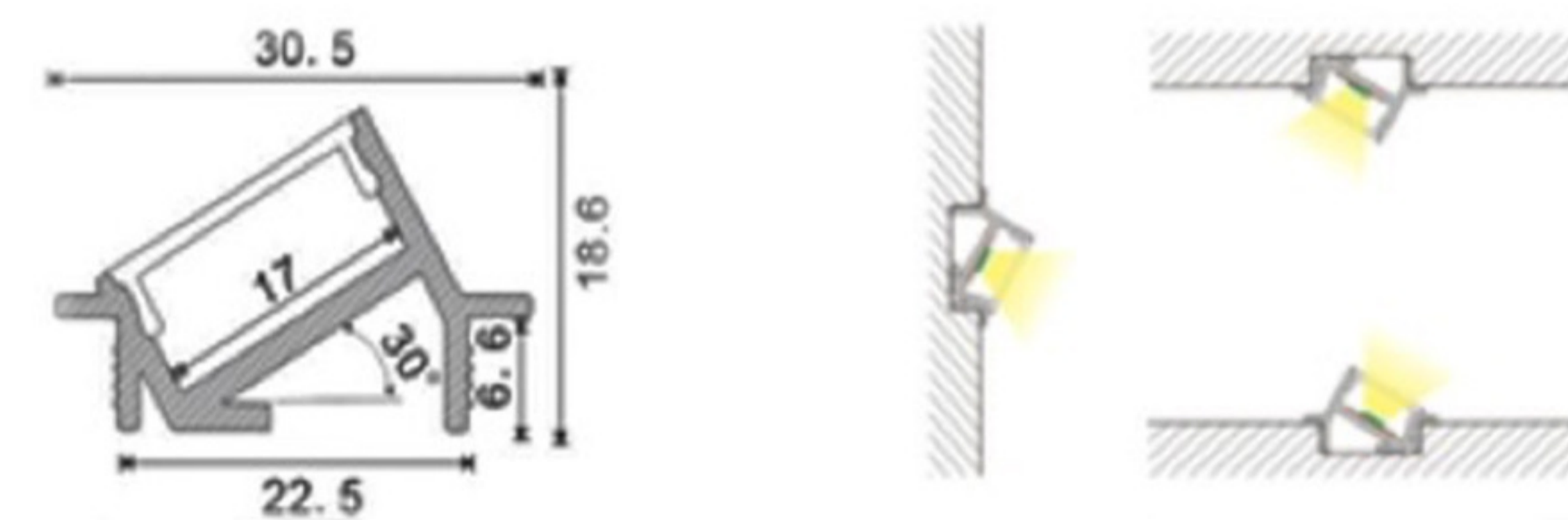

Linear.240- No Spotting
Linear.350- No Spotting
Linear.RGBW- Spotting Visible

Flush

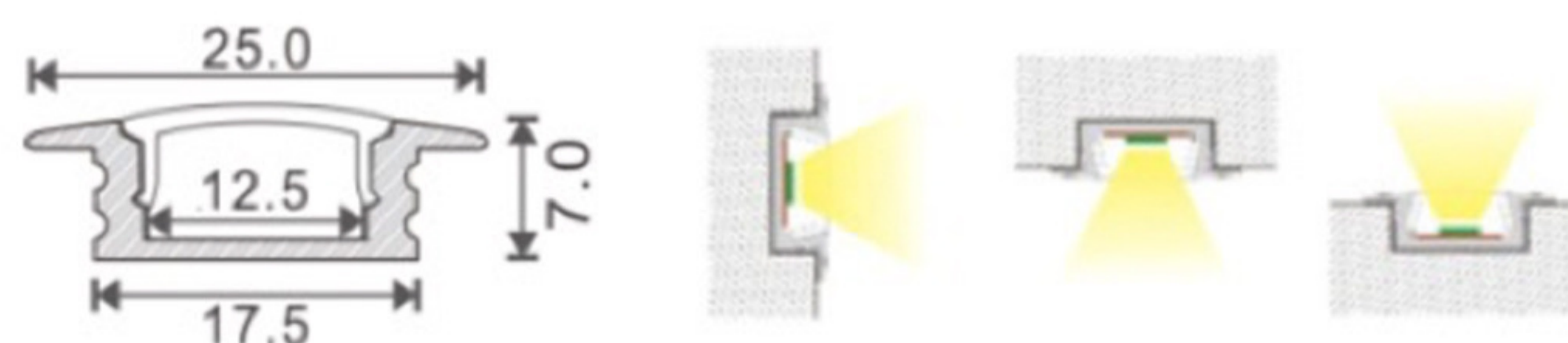
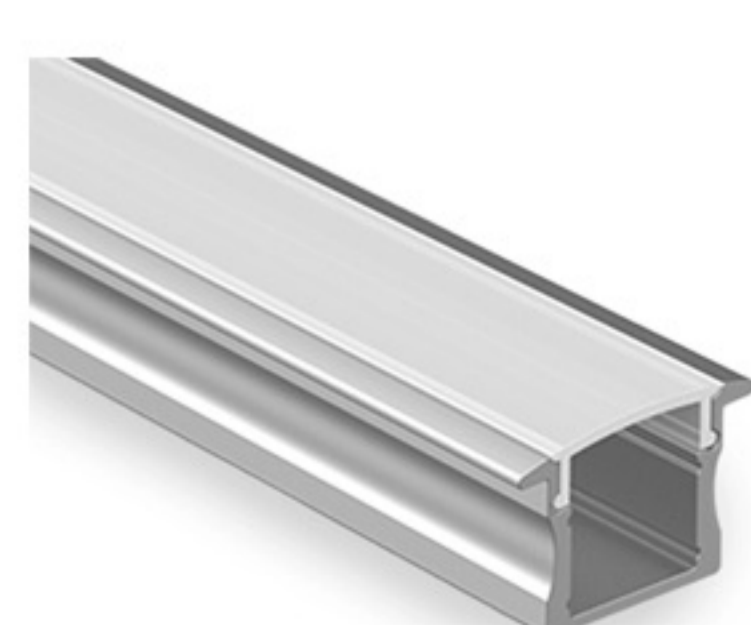

Linear.240- Spotting Visible
Linear.350- No Spotting
Linear.RGBW- Spotting Visible